

# VISUALIZING TEXT

Petra Isenberg

# RECAP

## STRUCTURED DATA



0.103	0.176	0.387	0.300	0.379
0.333	0.384	0.564	0.587	0.857
0.421	0.309	0.654	0.729	0.228
0.266	0.750	1.056	0.936	0.911
0.225	0.326	0.643	0.337	0.721
0.187	0.586	0.529	0.340	0.829
0.153	0.485	0.560	0.428	0.628

## UNSTRUCTURED DATA



(TODAY)

# VISUALIZING TEXT

**TEXT IS DIFFERENT**

**COMMON**

**UNSTRUCTURED (MOSTLY)**

**HIGH-DIMENSIONAL (10,000+)**

**BIG!**

**TEXT?**

# WHY

- To assist information retrieval
- To enable linguistic analysis
- To augment analytics on mixed data

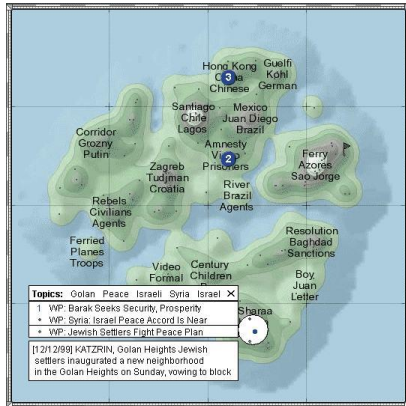

Themescape

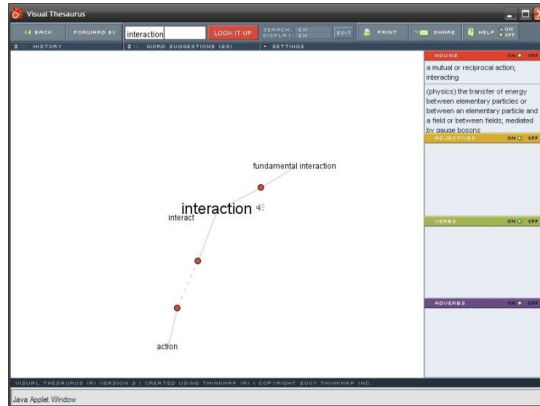

Visual Thesaurus

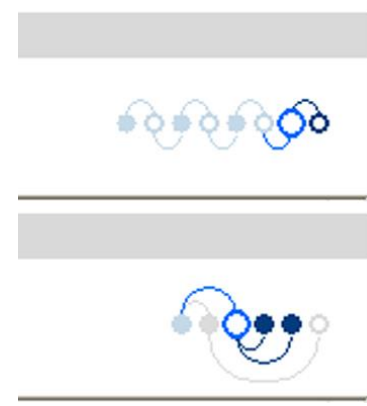

Thread Arcs

# WHY

**UNDERSTANDING:** GET THE “GIST” OF A DOCUMENT

**GROUPING:** CLUSTER FOR OVERVIEW OR CLASSIFICATION

**COMPARE:** COMPARE DOCUMENT COLLECTIONS, OR  
INSPECT EVOLUTION OF COLLECTION OVER TIME

**CORRELATE:** COMPARE PATTERNS IN TEXT TO THOSE IN  
OTHER DATA, E.G., CORRELATE WITH SOCIAL NETWORK

# WHAT IS TEXT

## DOCUMENTS

ARTICLES, BOOKS AND NOVELS  
COMPUTER PROGRAMS  
E-MAILS, WEB PAGES, BLOGS  
TAGS, COMMENTS

## COLLECTION OF DOCUMENTS

MESSAGES (E-MAIL, BLOGS, TAGS, COMMENTS)  
SOCIAL NETWORKS (PERSONAL PROFILES)  
ACADEMIC COLLABORATIONS (PUBLICATIONS)  
EVEN WHOLE LIBRARIES, WEBSITES, SOCIAL NETWORKS



# DIFFICULT DATA

- Too much data – what to use?
  - Millions of blog posts,
  - Hundreds of thousands of news stories,
  - 183 billion emails,
  - ... **per day**
- Data is noisy:
  - 70-72% of email is spam
  - Text contains section headings, figure captions, and direct quotes
  - ....

# ONCE YOU HAVE THE DATA...

- Most meaning comes from our minds and common understanding.
- “How much is that doggy in the window?”
  - how much: social system of barter and trade (not the size of the dog)
  - “doggy” implies childlike, plaintive, probably cannot do the purchasing on their own
  - “in the window” implies behind a store window, not really inside a window, requires notion of window shopping

(Hearst, 2006)

# LANGUAGE IS AMBIGUOUS

- Words and phrases can have many meanings, determined by context and world knowledge
- Interesting language is often figurative:
  - *America is a melting pot* (metaphor)
  - *Busy as a bee* (simile)
  - *Opportunity knocked on the door* (personification)
  - *You could have knocked me over with a feather* (hyperbole)

# LANGUAGE IS AMBIGUOUS

"I can't tell you how much I enjoyed meeting your husband."

(William Empson, *Seven Types of Ambiguity*, 1947)

"Brave men run in my family."

(Bob Hope as "Painless" Peter Potter in *The Paleface*, 1948)

# VISUAL CONSIDERATIONS

Supporters of Martin, who has been jailed without trial for more than two years, are calling on Prime Minister Stephen Harper to ask Mexican president Felipe Calderon to release Martin text is not preattentive under a section of the Mexican constitution that allows the government to expel undesirables from the country. Martin's supporters believe she has no chance of a fair trial in Mexico. Neither does Waage.

# VISUAL CONSIDERATIONS

Supporters of Martin, who has been jailed without trial for more than two years, are calling on Prime Minister Stephen Harper to ask Mexican president Felipe Calderon to release Martin **text is not preattentive** under a section of the Mexican constitution that allows the government to expel undesirables from the country. Martin's supporters believe she has no chance of a fair trial in Mexico. Neither does Waage.

# VISUAL CONSIDERATIONS



Text readability is dependent on size, orientation, font, clutter...

# VISUAL CONSIDERATIONS

- Text readability is dependent on size, orientation, font, clutter...
- More likely to need large amounts of text in language visualization



# VISUALIZING LANGUAGE IS ALSO EASY!

- SO much data available for analysis
- (Mostly) readily computer readable
- Simple techniques can give instant summaries

# OUTLINE

- **TEXT AS DATA**
- **VISUALIZING DOCUMENT CONTENT**
- **EVOLVING DOCUMENTS**
- **DOCUMENT COLLECTIONS**

**TEXT AS DATA**

**Words are  
the basic  
unit of data.**

# WORD-LEVEL ATTRIBUTES

- WORD LENGTH
- PART OF SPEECH (NOUN, VERB, ADJECTIVE, ETC.)
- FORMAT (*ITALIC*, UNDERLINE, ETC.)
- LANGUAGE (ENGLISH? LATIN? JAPANESE?)
- FREQUENCY / DIFFICULTY (IS IT COMMON?)
- SENTIMENT (POSITIVE OR NEGATIVE CONNOTATION)
- SYNONYMS / ANTONYMS / ETYMOLOGY (OTHER MEANINGS? ROOTS?)
- ENTITIES (e.g. “Calgary”, “Obama”, “Telus” )
- ... AND MANY MORE

# AGGREGATION

REPETITION  
PLAGARISM  
SHARED ENTITIES  
AUTHOR STYLE

## COLLECTION

- DOCUMENT
- SECTION
- PAGE
- PARAGRAPH
- SENTENCE
- WORD

TENSE  
SENTIMENT  
SENTENCE LENGTH  
READING LEVEL

# LINGUISTIC METHODS

- Word Counting
- Word Scoring
- Stemming
- Stop Word Removal
- Part of Speech Tagging
- Parsing
- Word Sense Disambiguation
- Named Entity Recognition
- Semantic Categorization
- Sentiment Analysis
- Topic Modeling (some caveats)

# WHAT ABOUT THESE WORDS?

automate  
automates  
automatic  
automation



**automat**

~~a, an, the, to, ...~~

“ New York”

“ Ban Ki-moon”

“ Manchester United”



# STEMMING

- Reduce words to their 'stems' by removing endings (morphology)
  - running -> run
  - runs -> run
- A good way to increase signal and reduce fracturing of the corpus if there aren't many words.
- Note: Keep the original words somewhere! Also keep the case if you choose to lowercase the word; you never know when you'll need this data

# STOP WORD REMOVAL

- Common words such as “and”, “the”, “I” are removed from view to highlight content words
- Domain specific stop words, e.g. in legal domain:
  - Court, attorney, honour, plaintiff, etc.
- Caution! These words have been shown to be useful for stylistic analysis! When working with text corpora, KEEP EVERYTHING.

# NAMED ENTITY RECOGNITION

- What are the people, places in the text?
- Use NLTK – it's very good at this.

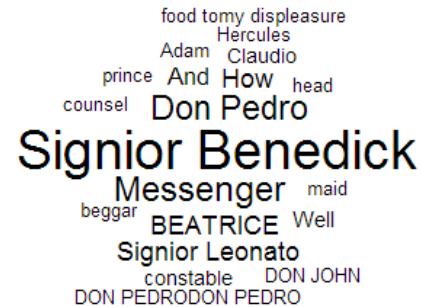
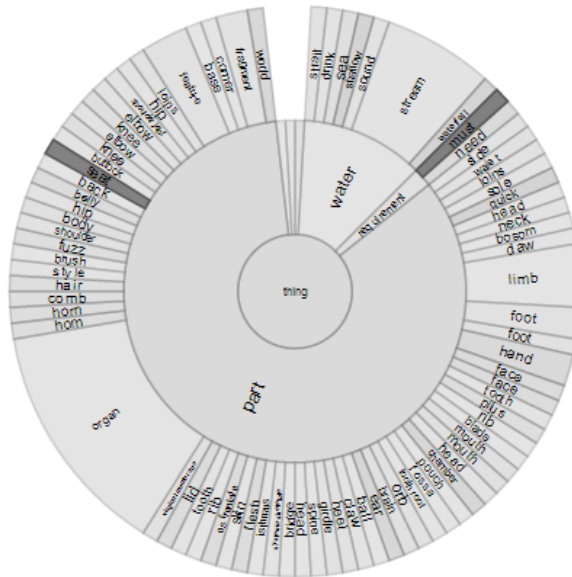

Much Ado About Nothing



<http://vialab.science.uoit.ca/docuburst>

# TEXT PROCESSING

## TOKENIZATION: SEGMENT TEXT INTO TERMS

ENTITIES? "SAN FRANCISCO", "O'CONNOR", "U.S.A."

REMOVE STOP WORDS? "A", "AN", "THE", "TO", "BE"

N-GRAMS? CAN TAKE WORDS IN 2-WORD GROUPS (BI-GRAMS), 3-WORD (TRI-GRAMS), ETC.

## STEMMING: GROUP TOGETHER DIFFERENT FORMS

ROOTS: VISUALIZATION(S), VISUALIZE(S), VISUALLY → VISUAL

LEMMATIZATION: GOES, WENT, GONE → GO

FOR VISUALIZATION, SOMETIMES NEED TO REVERSE STEMMING FOR LABELS

SIMPLE SOLUTION: MAP FROM STEM TO THE MOST FREQUENT WORD

## RESULT: ORDERED STREAM OF TERMS

# TEXT PROCESSING

“The quick brown fox jumps over the lazy dog.”

**TOKENIZE (N=1)**

[The], [quick], [brown], [fox], [jumps], [over], [the], [lazy], [dog].

**TOKENIZE (N=1), REMOVE STOPWORDS, STEM**

[quick], [brown], [fox], [jump], [over], [lazy], [dog]

**TOKENIZE (N=2)**

[the quick], [quick brown], [brown fox], [fox jumps], [jumps over], [over the]...

**TOKENIZE (N=5)**

[the quick brown fox jumps], [quick brown fox jumps over], [brown fox jumps over]

...

# Google Books Ngram Viewer

Graph these comma-separated phrases:   case-insensitive

between  and  from the corpus  with smoothing of  [Search lots of books](#)

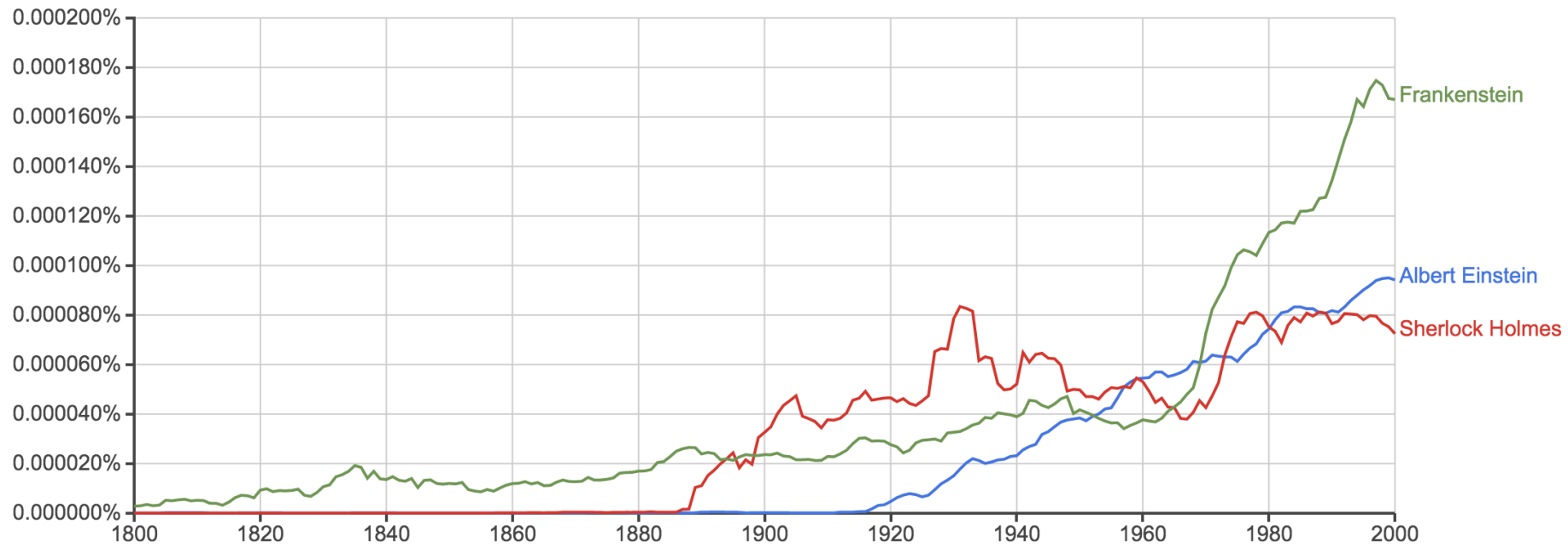

(click on line/label for focus)

# NLTK (NATURAL LANGUAGE TOOLKIT)

Tokenize and tag some text:

```
>>> import nltk
>>> sentence = """At eight o'clock on Thursday morning
... Arthur didn't feel very good."""
>>> tokens = nltk.word_tokenize(sentence)
>>> tokens
['At', 'eight', "o'clock", 'on', 'Thursday', 'morning',
'Arthur', 'did', "n't", 'feel', 'very', 'good', '.']
>>> tagged = nltk.pos_tag(tokens)
>>> tagged[0:6]
[('At', 'IN'), ('eight', 'CD'), ("o'clock", 'JJ'), ('on', 'IN'),
('Thursday', 'NNP'), ('morning', 'NN')]
```

NLTK.org  
Python

Identify named entities:

```
>>> entities = nltk.chunk.ne_chunk(tagged)
>>> entities
Tree('S', [(('At', 'IN'), ('eight', 'CD'), ("o'clock", 'JJ'),
('on', 'IN'), ('Thursday', 'NNP'), ('morning', 'NN')),
Tree('PERSON', [(('Arthur', 'NNP')]),
('did', 'VBD'), ("n't", 'RB'), ('feel', 'VB'),
('very', 'RB'), ('good', 'JJ'), ('.', '.')])])
```

# DOCUMENT CONTENT



BUT FIRST **SOME SKETCHING**

# SKETCHING: VISUALIZE

IMAGINE YOU HAVE 20 YEARS OF  
SCIENTIFIC PAPER ABSTRACTS:

YEAR

CONFERENCE

AUTHORS

TITLE

PAPER TYPE

KEYWORDS

REFERENCES

ABSTRACT TEXT

TASK:

1) **VISUALIZE THE MOST  
IMPORTANT CONTENT**  
FROM A SINGLE PAPER.

2) **VISUALIZE HOW SIMILAR  
PAPERS FROM EACH  
CONFERENCE** ARE TO PAPERS  
FROM OTHER CONFERENCES.

**GROUPS OF 3**

(~10 MINUTES)

# EXAMPLE

**Tools & Strategies for Social Data Analysis**

by

Wesley Jay Willett

A dissertation submitted in partial satisfaction of the  
requirements for the degree of  
Doctor of Philosophy

in

Computer Science

in the

Graduate Division

of the

University of California, Berkeley

# TAG CLOUDS

## WORD COUNT

additional air **analysis** **analysts** annotation applications approach asked author  
average based build **chart** citizen **clustering** collaborative collection  
**comments** commentspace community complete condition contributions  
crowd crowdsourcing **data** datasets design different discussion evidence example  
experiment experts **explanations** explore features figure  
filtering **generated** group help hypotheses hypothesis identify including indicating  
information interactive interface knowledge **links** members microtasks multiple novice number oae  
observations organize **participants** phases pp proceedings process produced  
prompt **provide quality** questions rate redundant requires **responses results** score  
sense share showing similar site **social source** specific state strategies study support  
systems **tags tasks tools** understanding used **users views**  
**visualization** web work **workers**





# TAG CLOUDS

## STRENGTHS

CAN HELP WITH GISTING AND INITIAL QUERY FORMATION.

## WEAKNESSES

SUB-OPTIMAL VISUAL ENCODING (SIZE VS. POSITION)

INACCURATE SIZE ENCODING (LONG WORDS ARE BIGGER)

MAY NOT FACILITATE COMPARISON (UNSTABLE LAYOUT)

- ORDER USUALLY MEANINGLESS (USUALLY ALPHABETICAL OR RANDOM)

TERM FREQUENCY MAY NOT BE MEANINGFUL

DOES NOT SHOW THE STRUCTURE OF THE TEXT

# WORD COUNTS

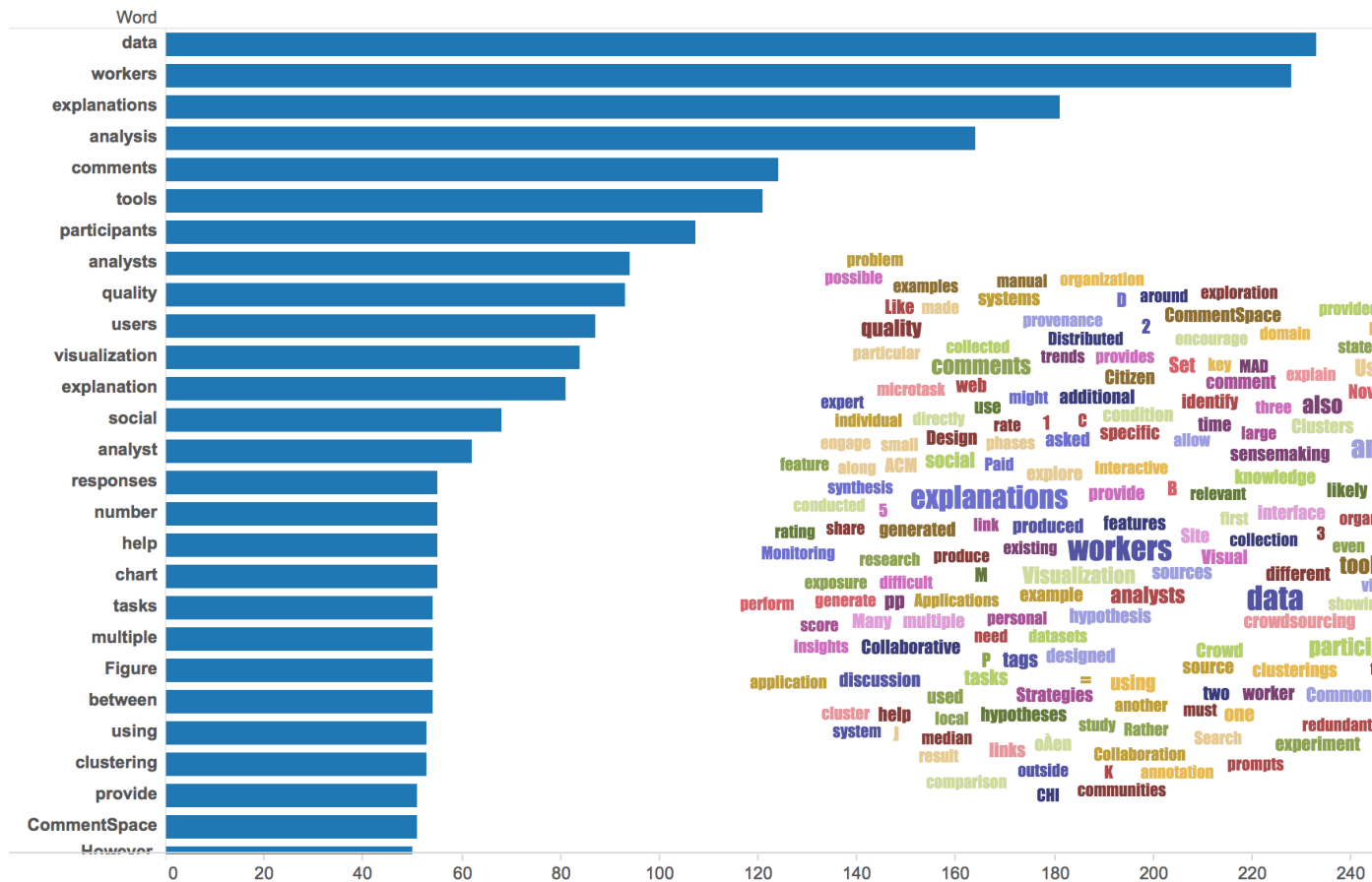



# WORDCOUNT

WORDCOUNT

◀ PREVIOUS WORD

NEXT WORD ▶

the of and to a in that it is was i for on you he be with as by a have are this no but had his they from she which we in there were go do you all has you'll will for when no in about pen and the the the the the the  
1 2 3 4 5 6 7 8 9 10 11 12 13 14 15 16 17 18 19 20 21 22 23 24 25 26 27 28 29 30 31 32 33 34 35 36 37 38 39 40 41 42 43 44 45 46 47 48 49 50

CURRENT WORD

FIND WORD:

BY RANK:

REQUESTED WORD: THE

RANK: 1

ARCHIVE

COUNT



JONATHAN HARRIS

<http://wordcount.org>

# CONCORDANCE

WHAT IS THE COMMON LOCAL CONTEXT OF A TERM?

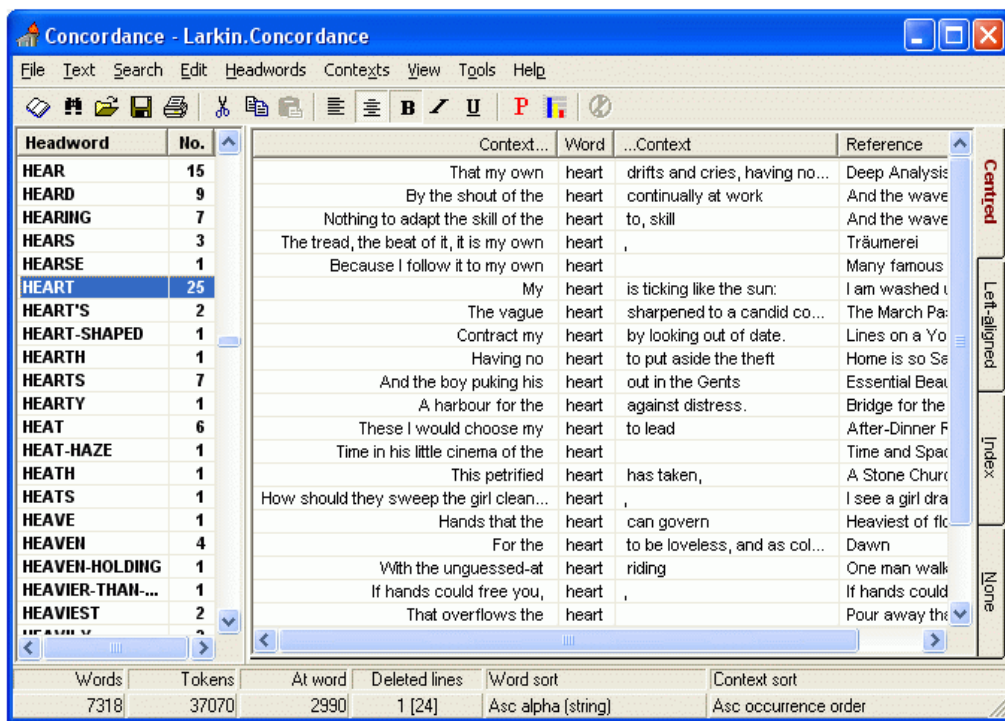

The screenshot shows the Concordance - Larkin.Concordance application window. The main window displays a list of words and their occurrences in a text file. The window has a menu bar (File, Text, Search, Edit, Headwords, Contexts, View, Tools, Help) and a toolbar with various icons. The main area is divided into several columns: Headword, No., Context..., Word, ...Context, and Reference. The word 'HEART' is highlighted in blue, indicating it is the current selection. The status bar at the bottom shows the following statistics: Words: 7318, Tokens: 37070, At word: 2990, Deleted lines: 1 [24], Word sort: Asc alpha (string), Context sort: Asc occurrence order.

Headword	No.	Context...	Word	...Context	Reference
HEAR	15	That my own	heart	drifts and cries, having no...	Deep Analysis
HEARD	9	By the shout of the	heart	continually at work	And the wave
HEARING	7	Nothing to adapt the skill of the	heart	to, skill	And the wave
HEARS	3	The tread, the beat of it, it is my own	heart	,	Träumerei
HEARSE	1	Because I follow it to my own	heart		Many famous
HEART	25	My	heart	is ticking like the sun:	I am washed t
HEART'S	2	The vague	heart	sharpened to a candid co...	The March Pa
HEART-SHAPED	1	Contract my	heart	by looking out of date.	Lines on a Yo
HEARTH	1	Having no	heart	to put aside the theft	Home is so Se
HEARTS	7	And the boy puking his	heart	out in the Gents	Essential Bea
HEARTY	1	A harbour for the	heart	against distress.	Bridge for the
HEAT	6	These I would choose my	heart	to lead	After-Dinner F
HEAT-HAZE	1	Time in his little cinema of the	heart		Time and Spac
HEATH	1	This petrified	heart	has taken,	A Stone Churr
HEATS	1	How should they sweep the girl clean...	heart	,	I see a girl dra
HEAVE	1	Hands that the	heart	can govern	Heaviest of fic
HEAVEN	4	For the	heart	to be loveless, and as col...	Dawn
HEAVEN-HOLDING	1	With the unguessed-at	heart	riding	One man walk
HEAVIER-THAN...	1	If hands could free you,	heart	,	If hands could
HEAVIEST	2	That overflows the	heart		Pour away the

# WORD TREES

- cats are better than dogs
- cats eat kibble
- cats are better than hamsters
- cats are awesome
- cats are people too
- cats eat mice
- cats meowing
- cats in the cradle
- cats eat mice
- cats in the cradle lyrics
- cats eat kibble
- cats for adoption
- cats are family
- cats eat mice
- cats are better than kittens
- cats are evil
- cats are weird
- cats eat mice



# love the

## lord

### thy god

#### with all

thine heart , and with all thy soul ,  
 thy heart , and with all thy soul , and with all thy

and with all thy might .  
 that thou mayest live .

mind  
 strength , a

#### and

keep his charge , and his statutes , and his judgments , and his commandments , always .  
 to walk ever in his ways ; then shalt thou add three cities more for thee , beside these three : 19  
 that thou mayest obey his voice , and that thou mayest cleave unto him : for he is thy life , and t  
 to walk in his ways , and to keep his commandments and his statutes and his judgments , that thou mayest liv

#### and to

serve him with all your heart and with all your soul , 11 : 14 that i will give you the rain of your lar  
 walk in all his ways , and to keep his commandments , and to cleave unto him , and to serve him  
 to walk in all his ways , and to cleave unto him ; 11 : 23 then will the lord drive out all these nations from

with all your heart and with all your soul .

### your god

all ye his saints : for the lord preserveth the faithful , and plentifully rewardeth the proud doer .  
 hate evil : he preserveth the souls of his saints ; he delivereth them out of the hand of the wicked .  
 because he hath heard my voice and my supplications .

name of the lord , to be his servants , every one that keepeth the sabbath from polluting it , and taketh hold of my covenant  
 good , and establish judgment in the gate : it may be that the lord god of hosts will be gracious unto the remnant of joseph  
 evil ; who pluck off their skin from off them , and their flesh from off their bones ; 3 : 3 who also eat the  
 truth and peace .

other ; or else he will hold to the one , and despise the other . ye cannot serve god and mammon .

6 : 25 therefore i say unto  
 16 : 14 and the pharisees

### uppermost

rooms at feasts , and the chief seats in the synagogues , 23 : 7 and greetings in the markets , and to be called of  
 seats in the synagogues , and greetings in the markets .

### father

; and as the father gave me commandment , even so i do .  
 hath bestowed upon us , that we should be called the sons of god : therefore the world knoweth us not , because it knew him

brotherhood .  
 world , the love of the father is not in him .  
 brethren .  
 children of god , when we love god , and keep his commandments .

# FILTER INFREQUENT RUNS

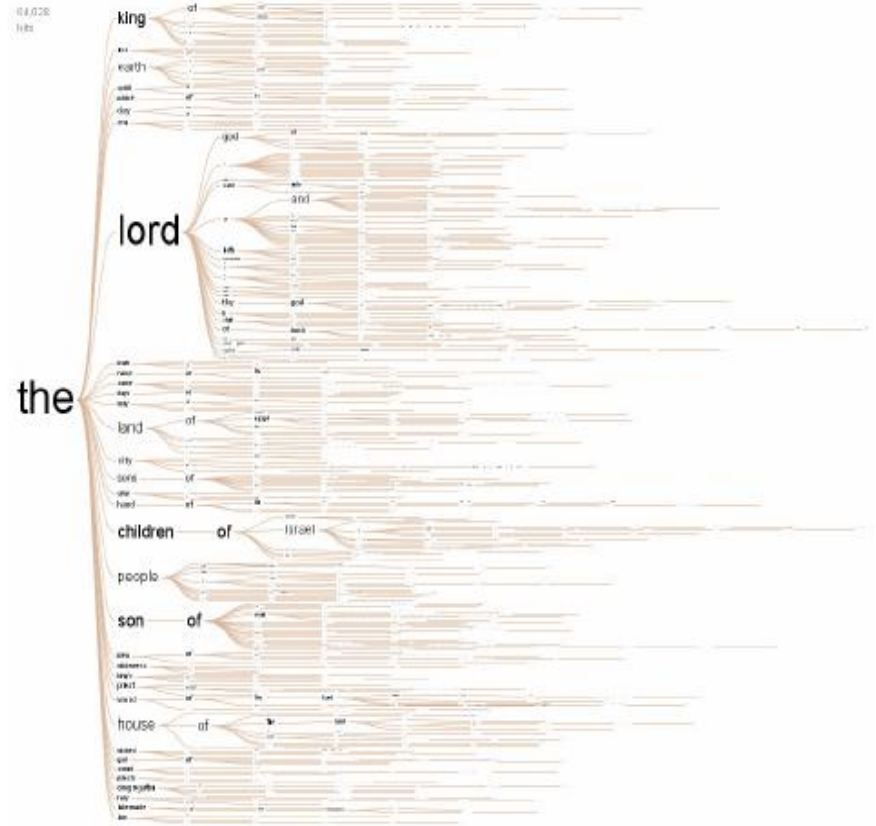
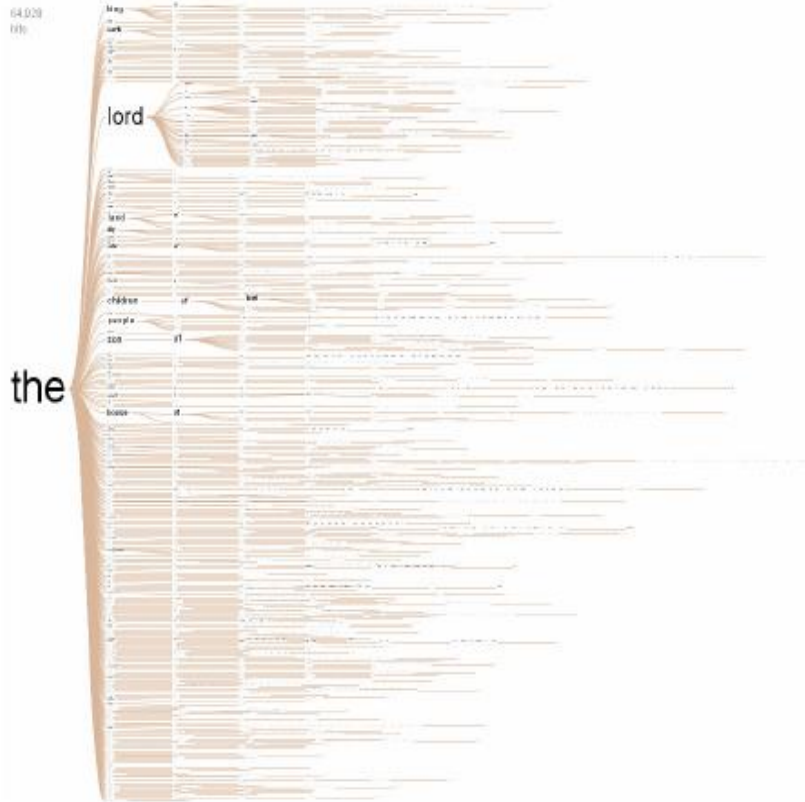

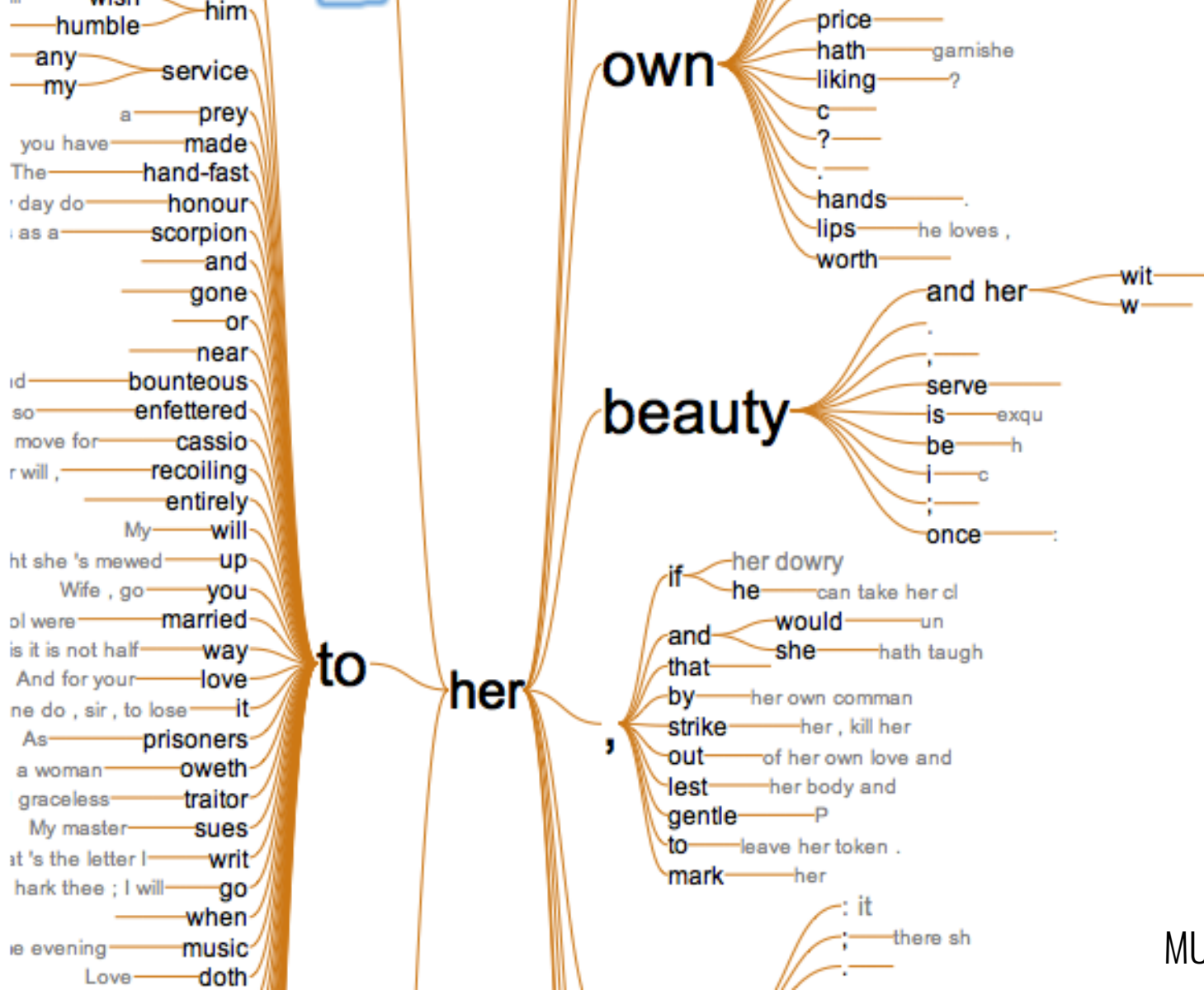

# RECURRENT THEMES IN SPEECH

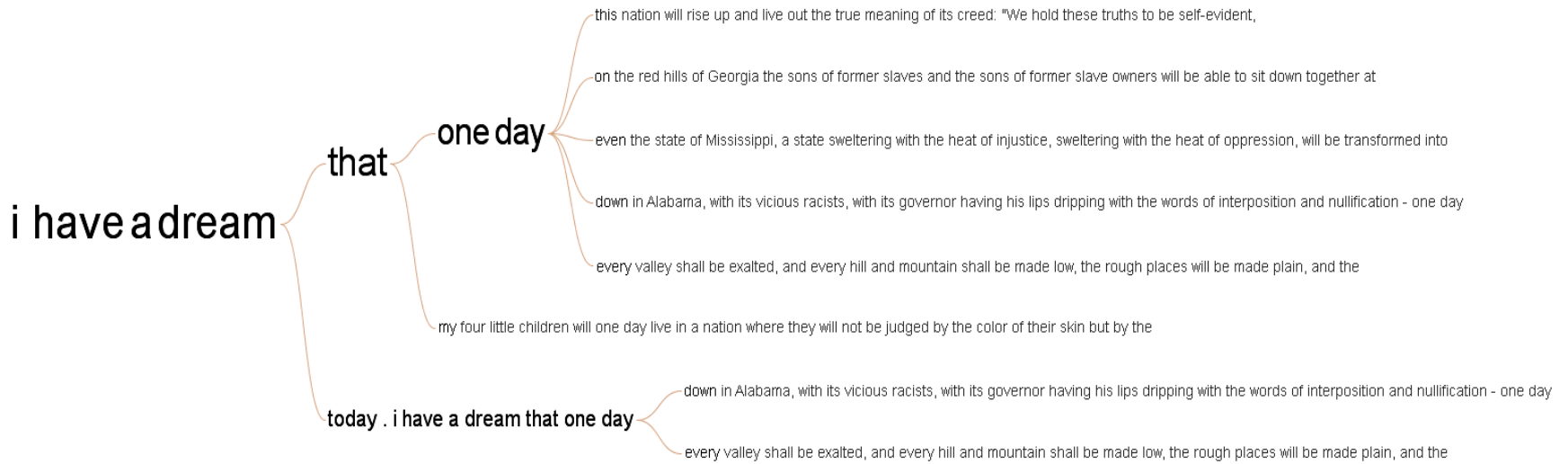

# GLIMPSES OF STRUCTURE

- CONCORDANCES SHOW LOCAL, REPEATED STRUCTURE
- BUT WHAT ABOUT OTHER TYPES OF PATTERNS?
- FOR EXAMPLE
- LEXICAL: <A> at <B>
- SYNTACTIC: <Noun> <Verb> <Object>



# PHRASE NETS

LOOK FOR SPECIFIC LINKING PATTERNS IN THE TEXT:

'A **AND** B', 'A **AT** B', 'A **OF** B', ETC

COULD BE OUTPUT OF REGEXP OR PARSER

VISUALIZE EXTRACTED PATTERNS IN A NODE-LINK VIEW

OCCURRENCES = NODE SIZE

PATTERN POSITION = EDGE DIRECTION

Showing 73 of 1719 terms

# X and Y

Select a phrase

word1 and word2

word1 's word2

word1 of the word2

word1 the word2

word1 a word2

word1 at word2

word1 is word2

word1 [space] word2

or enter your own

\* and \*

Submit

Filters

Show top: 100

Hide common words

Zoom

In Out Reset

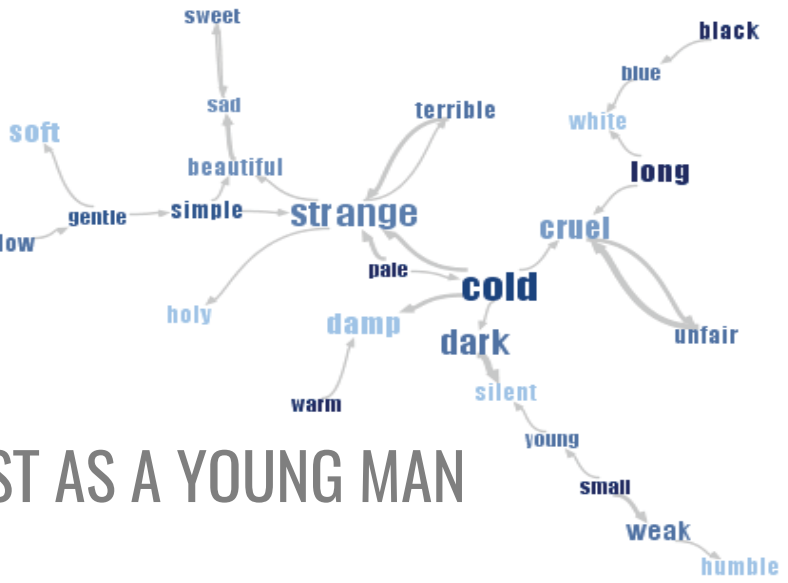

# PORTRAIT OF THE ARTIST AS A YOUNG MAN JAMES JOYCE

# NODE GROUPING

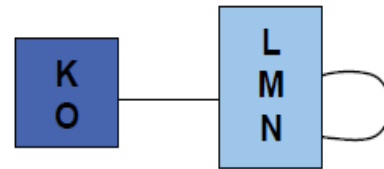
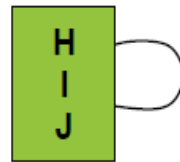
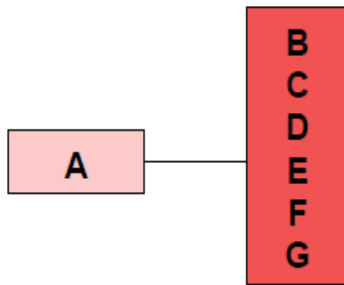
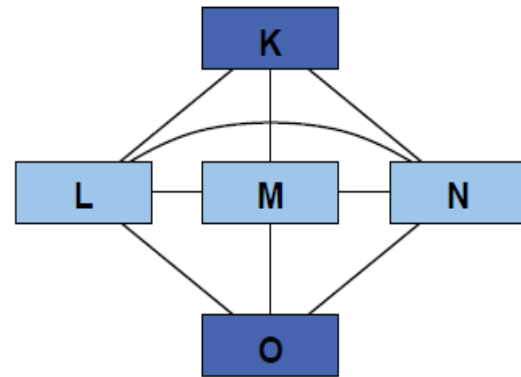
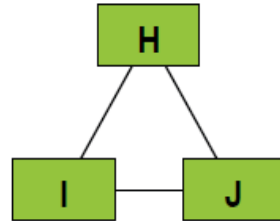
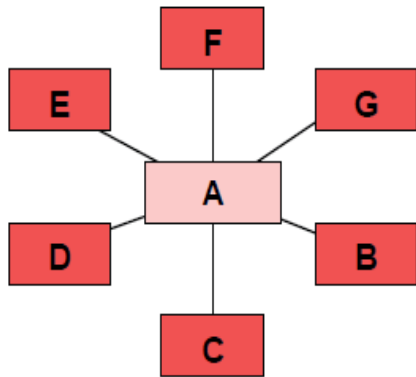

(a)

(b)

(c)

# THE BIBLE

{X} begat {Y}

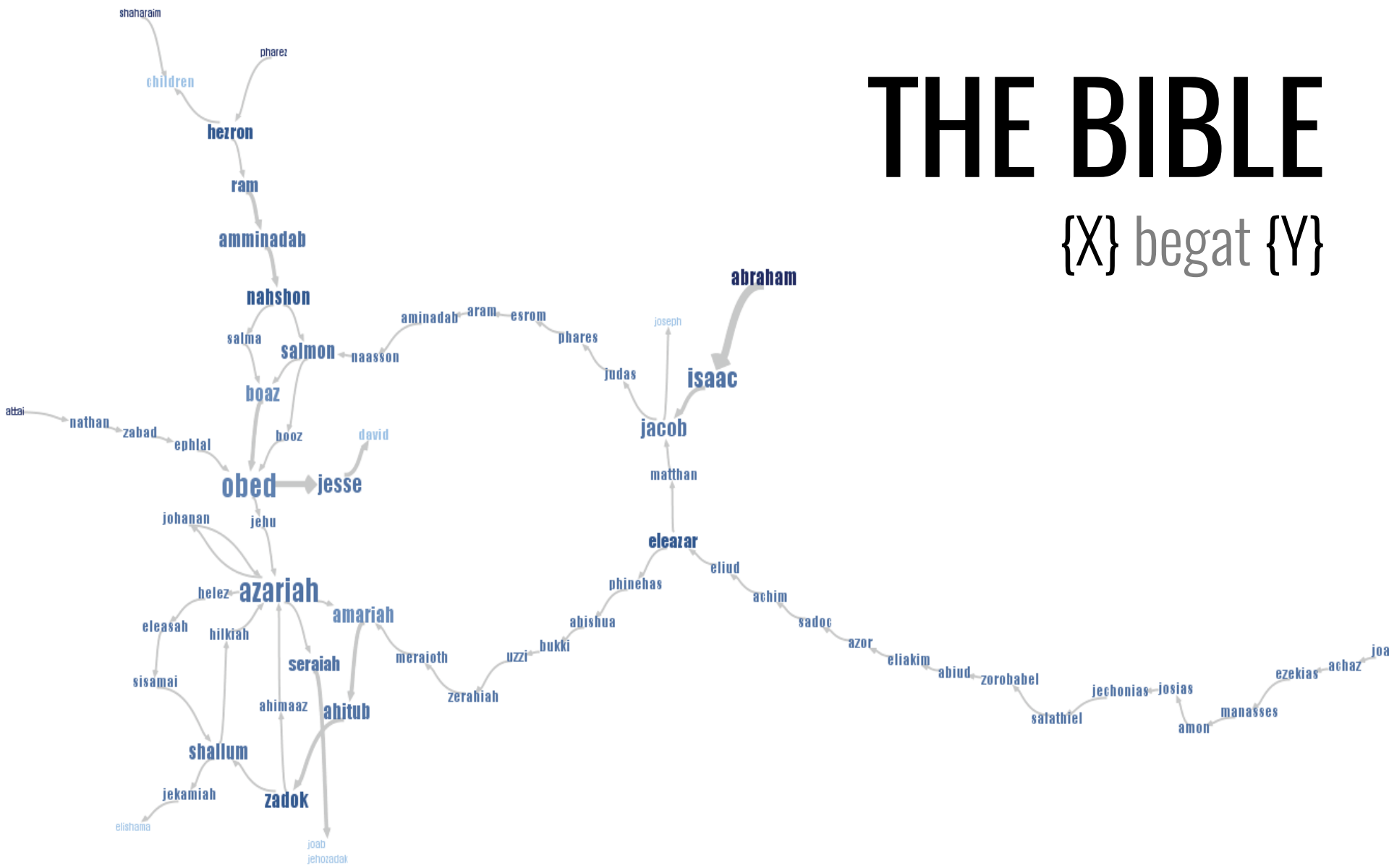







# RHYME, SPEECH, ETC.

POEMAGE McCurdy et al. 2016

Poemage v0.1

Set View

SONIC RHYMES

Identical Rhyme/Rhyme Riche

Perfect Masculine

Perfect Feminine

Perfect Dactylic

Semirhyme

Syllabic Rhyme

Consonant Slant Rhyme

Vowel Slant Rhyme

Pararhyme

Syllabic 2 Rhyme

Alliteration

Assonance

Consonance

Poem View

Machinations Calcite  
Clark Coolidge

acetone imprinted  
oblique swatch on the skin car barn oil wall  
ocarina & mumps  
much wet green  
I'd leave sole key to this game to my friend, sheep water cat

actor impressed  
weaving candle turn on computer cigarette, paper wall  
tarheels & balance  
a lot of yellow stick neck  
He'll have to hurry & carry away, to my blue friend hustling bringing  
his moon & car

agate inked  
merry melodies drool on shank of wet lead star tool  
crayon & sands  
length of granite buck drill  
It's sucking up the strand, his crystal flag, & the eels tube for that  
their parade swizzle fun

arctic suck  
splinter dry -ice spazz duke -ing ace supper at church  
hard pinks & sponge breath  
many forarms drift  
Roller window going up on I repeat my offer food list in iron flakes

Path View

Machinations Calcite

acetone

oblique swatch skin car

sole key this sheet cat

actor candle computer cigarette, stick neck carry hustling car

sands shank

sucking buck

arctic suck

ice luke ace supper at church

that,

swizzle

Modes: 1 2 3 shuffle nodes

clear beautiful mess

hover word show uncertainty custom set

show words show context fill intersecting paths

CONTEXT SLIDER

Poemage v0.1



# REVISIT YOUR SKETCHES?

TASK:

1) **VISUALIZE THE MOST IMPORTANT CONTENT** FROM A SINGLE PAPER.

ARE YOUR VISUALIZATION CHOICES **EFFECTIVE**?

DOES THE VIS CAPTURE THE **LENGTH, FORM, AND POSITION** OF THE IMPORTANT CONTENT?

DO YOU SHOW OR CONNECT BACK TO THE **ORIGINAL TEXT**?

# EVOLVING DOCUMENTS

# VISUALIZING REVISION HISTORY

## HOW TO DEPICT CONTRIBUTIONS AND CHANGES OVER TIME?

Revision history	
<b>October 30, 7:33 AM</b>	■ anonymous
<b>October 29, 3:13 PM</b>	■ anonymous
<b>October 29, 10:37 AM</b>	■ anonymous
<b>October 29, 9:57 AM</b>	■ anonymous
<b>October 29, 9:02 AM</b>	■ anonymous
<b>October 29, 5:21 AM</b>	■ anonymous
<b>October 28, 9:43 PM</b>	■ anonymous
<b>October 28, 4:48 PM</b>	■ Wesley Willett

Visit the main page



WIKIPEDIA  
The Free Encyclopedia

Main page  
Contents  
Featured content  
Current events  
Random article  
Donate to Wikipedia  
Wikipedia store

Interaction  
Help  
About Wikipedia  
Community portal  
Recent changes  
Contact page

Tools  
What links here  
Related changes  
Atom  
Upload file  
Special pages  
Page information  
Wikidata item

Languages

Article Talk

### Visualization: Revision history

View logs for this page

Browse history

From year (and earlier): 2016 From month (and earlier): all Tag filter: Show

For any version listed below, click on its date to view it. For more help, see [Help:Page history](#) and [Help:Edit summary](#).  
External tools: [Revision history statistics](#) · [Revision history search](#) · [Edits by user](#) · [Number of watchers](#) · [Page view statistics](#)

(cur) = difference from current version, (prev) = difference from preceding version, m = minor edit, → = section edit, ← = automatic edit summary  
(newest | oldest) View (newer 50 | older 50) (20 | 50 | 100 | 250 | 500)

Compare selected revisions

- [\(cur | prev\)](#) [17:57, 5 February 2016](#) Biscuitin (talk | contribs) . . (1,017 bytes) (+29) . . *(add link)* (undo)
- [\(cur | prev\)](#) [11:49, 10 April 2015](#) 87.103.115.78 (talk) . . (988 bytes) (-14) . . *(oops)* (undo)
- [\(cur | prev\)](#) [11:49, 10 April 2015](#) 87.103.115.78 (talk) . . (1,002 bytes) (-23) . . *(fix spelling)* (undo)
- [\(cur | prev\)](#) [14:30, 21 February 2015](#) Everymorning (talk | contribs) . . (1,025 bytes) (+20) . . *(add guided imagery)* (undo)
- [\(cur | prev\)](#) [13:30, 17 June 2014](#) Curious11 (talk | contribs) m . . (1,005 bytes) (+44) . . *(Sport psychology topic I initially was looking for...)* (undo)
- [\(cur | prev\)](#) [09:34, 12 February 2014](#) 134.246.168.123 (talk) . . (961 bytes) (+19) . . (undo)
- [\(cur | prev\)](#) [09:32, 12 February 2014](#) ClueBot NG (talk | contribs) m . . (942 bytes) (+820) . . *(Reverting possible vandalism by 134.246.168.123)* (undo)
- [\(cur | prev\)](#) [09:32, 12 February 2014](#) 134.246.168.123 (talk) . . (122 bytes) (-820) . . (undo)
- [\(cur | prev\)](#) [05:19, 2 March 2013](#) Legobot (talk | contribs) m . . (942 bytes) (-42) . . *(Bot: Migrating langlinks to WP:Wikidata - d:q:1696827)* (undo)
- [\(cur | prev\)](#) [23:28, 3 January 2013](#) Robofish (talk | contribs) . . (984 bytes) (-28) . . *(removed link to deleted article)* (undo)
- [\(cur | prev\)](#) [18:31, 21 March 2012](#) Jojan (talk | contribs) m . . (1,012 bytes) (+14) . . *(visualisation and visualization in wiktionary template)* (undo)
- [\(cur | prev\)](#) [19:11, 7 November 2011](#) DGRichard (talk | contribs) m . . (998 bytes) (+28) . . *(Added one more reference)* (undo)
- [\(cur | prev\)](#) [07:04, 25 September 2011](#) Cullen328 (talk | contribs) . . (970 bytes) (+23) . . *(add see also)* (undo)
- [\(cur | prev\)](#) [00:14, 9 July 2010](#) Squids and Chips (talk | contribs) m . . (947 bytes) (-19) . . *(remove {{Incoming links}})* (undo)
- [\(cur | prev\)](#) [15:29, 19 February 2010](#) Mdd (talk | contribs) . . (966 bytes) (+42) . . *(+ de:Visualisierung (Begriffsklärung))* (undo)
- [\(cur | prev\)](#) [15:30, 3 August 2009](#) Funandtrvl (talk | contribs) m . . (924 bytes) (-56) . . *(rm duplicates, copy-edit)* (undo)
- [\(cur | prev\)](#) [15:27, 3 August 2009](#) Funandtrvl (talk | contribs) m . . (980 bytes) (+20) . . *(WikiCleaner 0.90 - Repairing link to disambiguation)* (undo)
- [\(cur | prev\)](#) [03:25, 29 July 2009](#) FortdJ33 (talk | contribs) m . . (960 bytes) (-1) . . *(Clean up using AWB)* (undo)
- [\(cur | prev\)](#) [14:28, 28 July 2009](#) FortdJ33 (talk | contribs) m . . (961 bytes) (+19) . . *(Added tag)* (undo)
- [\(cur | prev\)](#) [13:29, 18 June 2009](#) C.J.L.L. Wright (talk | contribs) m . . (942 bytes) (-39) . . *(Reverted edits by Vizbi (talk) to last version by M.ne)* (undo)
- [\(cur | prev\)](#) [13:15, 18 June 2009](#) Vizbi (talk | contribs) . . (981 bytes) (+39) . . (undo)
- [\(cur | prev\)](#) [17:43, 18 March 2009](#) M.nelson (talk | contribs) . . (942 bytes) (+23) . . *(changed to "The term "visualization" or "visualisation"*

# DIFF

svn diff: sshconsole.js

Diff style: Side-by-side  Enable syntax coloring

Files Changed:

1. [sshconsole.js](#): 1 change [1]

/home/toddw/src/sshconsole-read-only/content/sshconsole.js

```
... 50 lines hidden [Expand]
51  _term = new VT100(80, 24, "term");
52  //_term.debug_ = 1;
53  _term.curs_set(true, true, _term_box_element);
54  _term.noecho();
55
56  // Replace the go_getch_ function with our own, this is called
57  // for every keypress that is passed through the terminal to the
58  // remote server. The character is already converted into the
59  // required VT100 character sequence(s).
60  VT100.go_getch_ = function() {
61    var vt = VT100.the_vt_;
62    if (vt === undefined) {
63      return;
64    }
65    var ch = vt.key_buf_.shift();
66    //dump("go_getch_:: ch: " + ch + "\n");
67    if (ch === undefined) {
68      return;
69    }
70    if (vt.echo_ && ch.length == 1) {
71      vt.addch(ch);
72    }
73    if (_ssh_channel) {
74      _ssh_channel.sendStdin(ch);
75    }
76  }
77
78  var serverTextbox = document.getElementById("sshconsole_server_textbox");
79  var connectionText;
80  if ('connectionText' in window.arguments[0]) {
81    connectionText = window.arguments[0].connectionText;
82  } else {
51  _term = new VT100(80, 24, "term");
52  //_term.debug_ = 1;
53  _term.curs_set(true, true, _term_box_element);
54  _term.noecho();
55
56  // Replace the go_getch_ function with our own, this is called
57  // for every keypress that is passed through the terminal to the
58  // remote server. The character is already converted into the
59  // required VT100 character sequence(s).
60  VT100.go_getch_ = function() {
61    var vt = VT100.the_vt_;
62    if (vt === somevalue) {
63      return;
64    }
65    var ch = vt.key_buf_.shift();
66    if (ch === undefined) {
67      return;
68    }
69    if (vt.echo_ && ch.length == 1) {
70      vt.addch(ch);
71      vt.refres();
72    }
73    if (_ssh_channel) {
74      _ssh_channel.sendStdin(ch);
75    }
76  }
77
78  var serverTextbox = document.getElementById("sshconsole_server_textbox");
79  var connectionText;
80  if ('connectionText' in window.arguments[0]) {
81    connectionText = window.arguments[0].connectionText;
82  } else {
... 174 lines hidden [Expand]
```

authors posts

198 37 26 168

- 1 Zundark 1
- 1 The Cunctator 1
- 1 The Epopt 1
- 1 Conversion script 1
- 1 Rik 1
- 1 Fredb 1
- 1 B4hand 1
- 1 KamikazeArchon 1
- 1 Stephen Gilbert 1
- 8 Sirubenstein 8
- 5 Mikccorn 5
- 1 Ista 1
- 1 Derek Ross 1
- 2 Dante Alighieri 2
- 3 Maveric143 3
- 2 Jazbug 2
- 8 Jodi 8
- 1 Theanthrope 1
- 2 Wiesley 2
- 4 Dreamword 4
- 1 Steverfgo 1
- 1 Camenbert 1
- 2 Hephaestus 2
- 1 Zee 1
- 1 MyRedDice 1
- 2 G-Man 2
- 1 Ringtarde 1
- 1 Montbreaks 1
- 1 Zee 1



### Abortion

(Revision as of 22:56 4 Jun 2003)

"**Abortion**," in its most commonly used sense, refers to the deliberate early termination of pregnancy, resulting in the death of the embryo or fetus. [1] Medically, the term also refers to the early termination of a pregnancy by natural causes ("spontaneous abortion" or miscarriage, which ends 1 in 5 of all pregnancies, usually within the first 13 weeks) or to the cessation of normal growth of a body part or organ. What follows is a discussion of the issues related to deliberate or "induced" abortion.

#### Methods

Depending on the stage of pregnancy an abortion is performed by a number of different methods. For the earliest terminations (before nine weeks or so) a chemical abortion is the usual method, the drug **mifepristone** is usually the only legal method although research has uncovered similar effects from **methotrexate** and **misoprostol**. Concurrent with chemical abortion and extending up until around the fifteenth week **suction-aspiration** or **vacuum abortion** is the most common approach, replacing the more risky **dilation and curettage** (D & C). From the fifteenth week up until around the eighteenth week a surgical **dilation and evacuation** (D & E) is used.

As the fetus size increases other techniques must be used to secure abortion in the third trimester, premature expulsion of the fetus can be induced with **prostaglandin**, this can be coupled with injecting the amniotic fluid with saline or urea solution. Very late abortions can be brought about by the controversial **intact dilation and extraction** (D & X) or a **hysterotomy abortion**, similar to a **caesarian section**.

#### The controversy

The morality and legality of abortion is a large and important topic in **applied ethics** and is also discussed by **legal scholars** and **religious people**. Important facts about abortion are also researched by **sociologists** and **historians**.

Abortion has been common in most societies, although it has often been opposed by some institutionalized religions and governments. In **20th century politics in the United States and Europe**, abortion became commonly accepted by the end of the 20th century. Additionally, abortion is legal and accepted in **China**, **India** and other populous countries. The **Catholic Church** remains opposed to the procedure, however, and in other countries, notably the **United States** and the (predominantly Catholic) **Republic of Ireland**, the controversy is still extremely active, to the extent that even the names of the respective positions are subject to heated debate. While those on both sides of the argument are generally peaceful, if heated, in their advocacy of their positions, the debate is sometimes characterized by violence. Though true of both sides, this is more marked on the side of those opposed to abortion, because of what they see as the gravity and urgency of their views.

#### The central question

The central question in the abortion debate is a clash of presumed or perceived rights. On the one hand, is a fetus (sometimes called the "unborn" by pro-life/anti-abortion advocates) a human being with a right to life, and if so, at what point in the

# WIKIPEDIA HISTORY FLOW VIÉGAS ET AL 2004

# ANIMATED TRACES

fathom.info/traces

ON THE ORIGIN OF SPECIES *The Preservation of Favoured Traces*

I

II

III

IV

V

VI

VII

VIII

IX

head, not known to be electrical, but which appears to be the real homologue of the electric battery in the Torpedo. It is generally admitted that there exists between these organs and ordinary muscle a close analogy, in intimate

**BEN FRY**



Reset

Pause

Slow

Fast

I

II

III

IV

V

VI

VII

VIII

IX

X

XI

XII

XIII

XIV

■ First Edition (1859)

■ Second Edition (1860)

■ Third Edition (1861)

■ Fourth Edition (1866)

■ Fifth Edition (1869)

■ Sixth Edition (1872)

# DIFFAMATION

## Using Text Animated Transitions to support Navigation in Document Histories



**Fanny  
Chevalier**



**Pierre  
Dragicevic**



**Anastasia  
Bezerianos**



**Jean-Daniel  
Fekete**



# VISUALIZING DOCUMENT COLLECTIONS

# Analysts: GOP may regret Scalia replacement

# Update: Uber driver arrested in Michigan rampage that killed 6

# Boris Johnson backs EU exit: London mayor confirms support for Brexit

# 'A multifaceted catastrophe': Turkey has 'so alienated everyone

# Blasts rock Syrian city of Homs, killing at least 32

# Palestinians struggle to define those who attack Israelis

**Canada, USA renew rivalry in CONCACAF final**



Sportsnet's James Sharman met with coach John Herdman and members of the Canadian women's soccer team, who are looking to beat the USA in Sunday's CONCACAF final, headshot Gavin Day February 20, 2016, 8:08 PM. headshot Gavin Day February

Feb 20 17:47 | 587 related articles | Sportsnet.ca

# US rejected North Korea peace talks offer before last nuclear test

# Malaysia, south-east Asia nations wamed of terror attacks

# Samsung, LG unveil new devices in bid for smartphone recovery

# Raceline Radio Program Guide: February 21, 2016

# Canada, USA renew rivalry in CONCACAF final

# 'Deadpool' dominates again with \$55 million in 2nd week

# Judge blocks attempt to halt deposition of Bill Cosby's wife

LG Unveils the LG G5, Its First Modular Smartphone [Video]

LG G5 vs LG V10: first look

EPA asks Volkswagen to make electric cars in the US

Lenovo Open Firmware, the Open Firmware that makes

# Chan wins Four Continents figure-skating championship

# Truex comes up a few inches short in closest Daytona 500

Years later, ex-Raptor Vince Carter's still soaring

SPRING TRAINING Blue Jays' focus at 2016 camp is on 2017

Canadian women earn historic 19-10 rugby victory over New Zealand

Miller puts an end to Canucks' losing streak

Leafs get set for a busy draft with Matthias trade

# Scientists at Brock studying Zika to see if Canadian mosquitoes can spread the virus

HPV cases drop since vaccinations started

Asian stocks rebound in anticipation of G20 meeting

Asian stocks rebound in anticipation of G20 meeting

Highlights from the USC report on entertainment diversity

Obama, Romney win at ACTA Toronto

WORLD 'The Day After Tomorrow' remake US presidential candidates in 'The Network Effect'

Obama, Romney win at ACTA Toronto

La Roche staff, students return to school this week

Obama, Romney win at ACTA Toronto

Police officers return to work in the wake of the Ontario Police strike

Obama, Romney win at ACTA Toronto

# DOCUMENT CARDS

## SMALL MULTIPLES FOR DOCUMENTS

**Cerebral: Visualizing Multiple Experimental Conditions on a Graph with Biological Context**

4 systems biologist context interaction graph graph model dataset figure

1 2 3 4 5 6 7 8

edge tool cell gene layout algorithm process node cerebral

Aaron Barsky, Tamara Munzner, Jennifer Gandy, and Robert Kincaid

**Multi-Focused Geospatial Analysis Using Probes**

probe interface

1 2 3 4 5 6 7 8

participant type window region-of-interest local region data application

Thomas Butkiewicz, Wenwen Dou, Zachary Wartell, William Ribarsky, and Remco Chang

**Stacked Graphs: Geometry & Aesthetics**

2 question visualization paper

1 2 3 4 5 6 7 8

comment york time algorithm trend nameviewer graphic time sery system legibility design issue layout method

Lee Byron and Martin Wattenberg

**Vispedia : Interactive Visual Exploration of Wikipedia Data via Search-Based Integration**

3

1 2 3 4 5 6 7 8

Bryan Chan, Leslie Wu, Justin Talbot, Mike Cammarano, and Pat Hanrahan

**Geometry-Based Edge Clustering for Graph Visualization**

4

1 2 3 4 5 6 7 8

edge bundle technique polyline segment large graph road map mesh edge pattern transfer function color and opacity enhancement node position control point graph layout result method visual cluster general graph primary direction

Weiwei Cui, Hong Zhou, Student1, Huamin Qu, Pak Chung Wong, and Xiaoming Li

**VisGets: Coordinated Visualizations for Web-based Information Exploration and Discovery**

5

1 2 3 4 5 6 7 8

map rss feed participant temporal information item data information space query parameter exploration set visget description

Marian Dirk, Sheelagh Carpendale, Christopher Collins, and Carey Williamson

**Who Votes For What? A Visual Query Language for Opinion Data**

6

1 2 3 4 5 6 7 8

user study report attribute paper sample population entity result sector opinion poll state street typical data set user interface visual query language visualization design participant ring position data point

poll data participant system data point

Geoffrey M. Drapes, and Richard F. Riesenfeld

**Exploration of Networks Using Overview+Detail with Constraint-based Cooperative Layout**

7

1 2 3 4 5 6 7 8

layout method route focal node user lod placement constraint level part system model detailed view uml class diagram display layout technique cluster position structure focus node

Tim Dawyer, Kim Marriott, Falk Schreiber, Peter J. Stuckey, Michael Woodward and Michael Wybrow

**Rolling the Dice: Multidimensional Visual Exploration using Scatterplot Matrix Navigation**

8

1 2 3 4 5 6 7 8

visual exploration data dimension query prototype implementation visual representation cameras digital camera dataset figure overview range scatterplot matrix user plane operation method order

Niklas Elmavist, Pierre Dragicevic, and Jean-Daniel Fekete

**Interactive Visual Analysis of Set-Typed Data**

9

1 2 3 4 5 6 7 8

bar block user scatterplot figure feature width data item dataset data record washing agent set-typed data view

Wolfgang Freiler, Kresimir Matkovic, Computer Society, and Helwig Hauser

**Graphical Histories for Visualization: Supporting Analysis, Communication, and Evaluation**

10

1 2 3 4 5 6 7 8

graphical history usage history item rule tableau image data field display approach event history interface history tool

Jeffrey Heer, Jack D. Mackinlay, Chris Stolte, and Maneesh Agrawala

**Improving the Readability of Clustered Social Networks using Node Duplication**

11

1 2 3 4 5 6 7 8

representation success rate social network time clonemode analysis visualization duplicate community noduplication duplication link splitlink readability

Nathalie Henry, Anastasia Bezerianos, and Jean-Daniel Fekete

# THEMERIVER HAVRE ET AL 1999

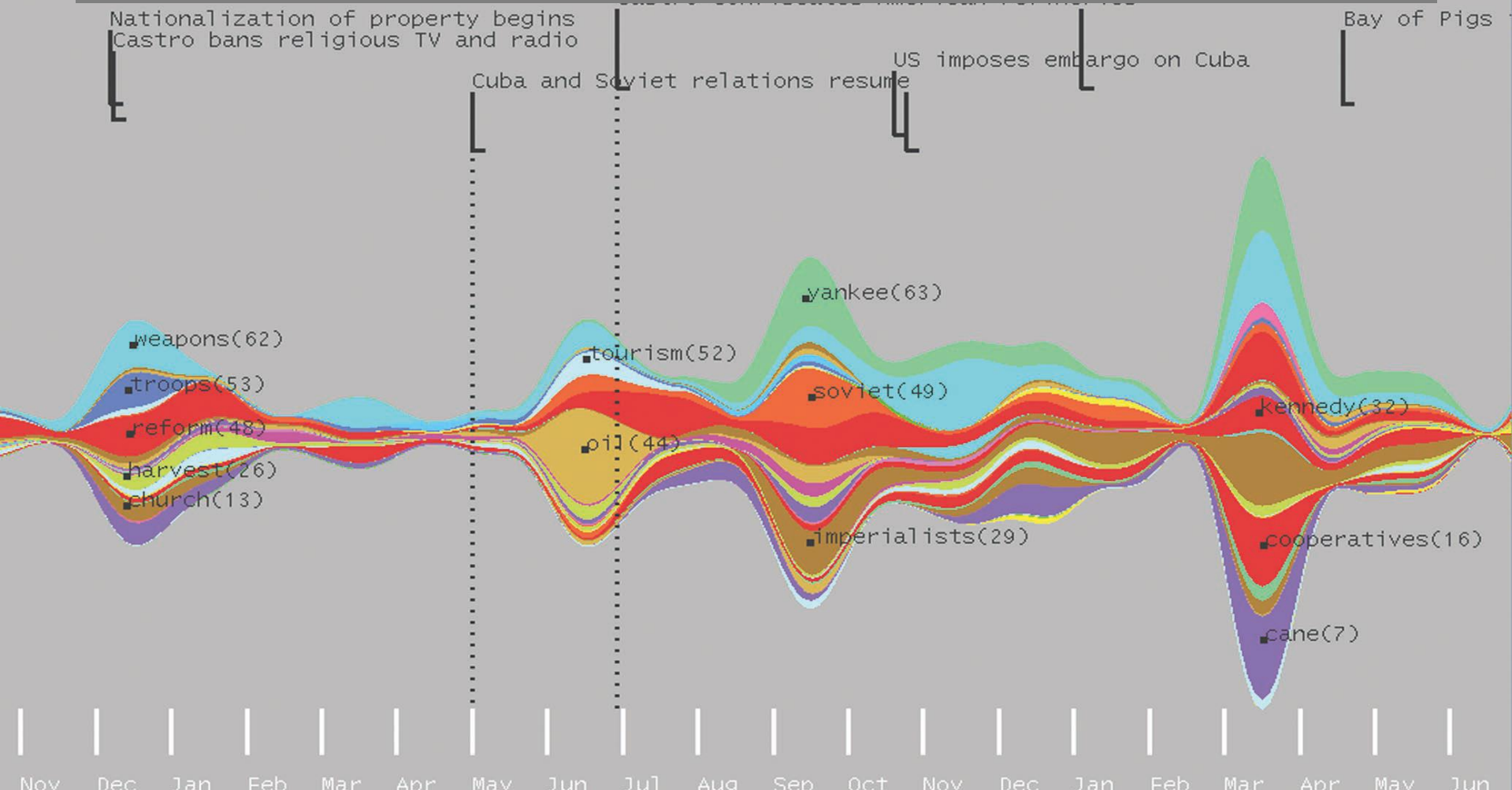



# SUPPORTING SEARCH

The screenshot shows a search interface with the following components:

- User Query:** A text area containing "osteoporosis", "prevention", and "research" on separate lines.
- Buttons:** "Run Search", "New Query", and "Quit".
- Search Limit:** A range selector with options 50, 100, 250, 500, and 1000. The value 250 is selected.
- Number of Clusters:** A range selector with options 3, 4, 5, 8, and 10. The value 5 is selected.
- Mode:** "Tile Bars".
- View Options:** "Cluster" and "Titles" buttons.
- Backup:** A "Backup" button.
- Results:** A list of search results, each with a small thumbnail on the left and a text snippet on the right. The results include:
  - FR88513-0157
  - AP: Groups Seek \$1 Billion a Year for Aging Research
  - SJMN: WOMEN'S HEALTH LEGISLATION PROPOSED CF
  - AP: Older Athletes Run For Science
  - FR: Committee Meetings
  - FR: October Advisory Committees; Meetings
  - FR88120-0046
  - FR: Chronic Disease Burden and Prevention Models; Program
  - AP: Survey Says Experts Split on Diversion of Funds for AIDS
  - FR: Consolidated Delegations of Authority for Policy Developm
  - SJMN: RESEARCH FOR BREAST CANCER IS STUCK IN P

**TileBars** Hearst 1999



# The 2007 State of the Union Address

Over the years, President Bush's State of the Union address has averaged almost 5,000 words each, meaning the the President has delivered over 34,000 words. Some words appear frequently while others appear only sporadically. Use the tools below to analyze what Mr. Bush has said.



## Use of the phrase "Tax" in past State of the Union Addresses

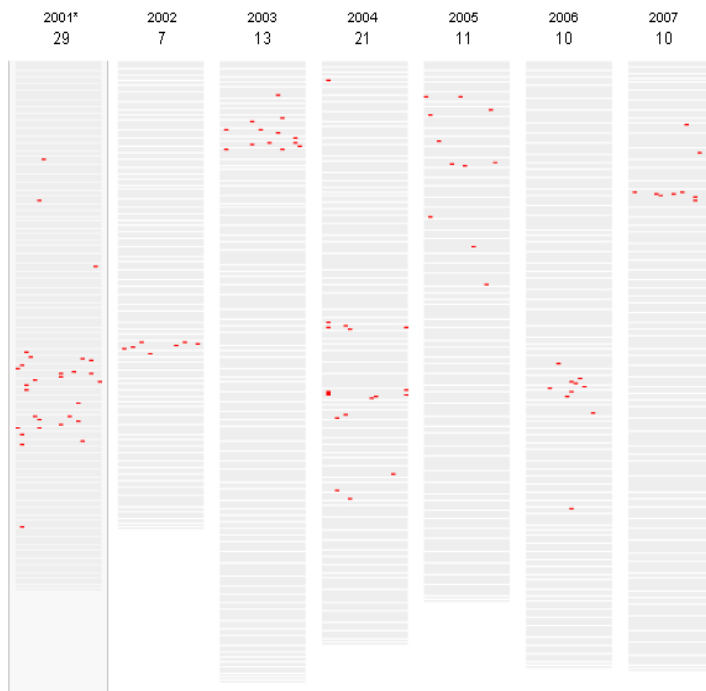

### The word in context

I believe in local control of schools. We should not, and we will not, run public schools from Washington, D.C. Yet when the federal government spends **TAX** dollars, we must insist on results. Children should be tested on basic reading and math skills every year between grades three and eight. Measuring is the only way to know whether all our children are learning. And I want to know, because I refuse to leave any child behind in America.

-- 2001 (Paragraph 14 of 73)

[Next instance of 'Tax'](#)

## Compared with other words

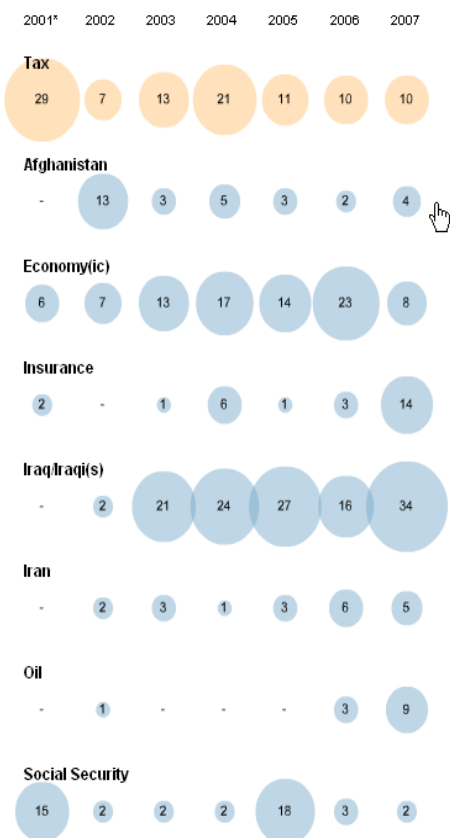

\* As a newly elected president, Mr. Bush did not deliver a formal State of the Union address in 2001. His Feb. 27 speech to a joint session of Congress was analogous to the State of the Union, but without the title.



# NAMED ENTITY RECOGNITION

**IDENTIFY AND CLASSIFY NAMED ENTITIES IN TEXT:**

JOHN SMITH IS A **PERSON**

SOVIET UNION IS A **COUNTRY**

2500 UNIVERSITY DR IS AN  
**ADDRESS**

(555) 867-5309 IS A **PHONE NUMBER**

**ENTITY RELATIONS:** HOW DO THE ENTITIES RELATE?

DO THEY CO-OCCUR IN A DOCUMENT? IN A SENTENCE?

List View

Edit View Bookmarks Lists Options Export

year Add all Clear

author Add all Clear

concept Add all Clear

- 1995
- 1996
- 1997
- 1998
- 1999
- 2000
- 2001
- 2002
- 2003
- 2004
- 2005
- 2006
- 2007
- 2008
- 2009
- 2010
- 2011

- Keim, D.A.
- Oelke, D.
- Schneidewind, J.
- Dayal, U.
- Hao, M.C.
- Mansmann, F.
- North, S.
- Panse, C.
- Sips, M.
- Bak, P.
- Janetzko, H.
- Robrdantz, C.
- Schroek, T.
- Stoffel, A.
- Albuquerque, G.
- Ankerst, M.
- Berchtold, S.
- Danon, G.
- Deussen, O.
- Eisemann, M.
- Grise, T.
- Haug, L. E.
- Heilmann, R.
- Hsu, M.
- Jenny, M.
- Ladisch, J.
- Last, M.
- Mignone, M.
- Muennich, D.

- insight
- text
- pixel
- distortion
- document
- geographic
- hierarchy
- interaction
- parallel coordinates
- case study
- clustering
- color
- evaluation
- network
- time series
- treemap
- animation
- business
- cluster
- financial
- geospatial
- high dimensional da...
- overview
- radial
- security
- toolkit
- visual analytics
- zooming
- mathematics

Document Cluster View

Edit View Bookmarks Export Options

right viewed documents

Filters

All Filters

Group by Filters

Undo Filters

Hide Unfiltered

Clusters

Text Seed (30)

First Words Unique Words

- All Documents
- visual animation,trends: 21
- visualization,users,tablec
- visualization,user,transf
- visualization,use,classif
- visual insight,genes: 19
- visualization,tree,eye: 56
- visualization,users,space

animation,trends,causality

transforms,quality,studied

night,genes,expression

tables,database,interfaces

classification,geographic,statistics

treemaps,coloring,hierarchicaly

dimensions,coordinates,parallel

network,graph,social

graphs,edge,algorithm

spaces,internet,search

interact,understand,cognition

text,features,topic

video,explorer,stories

collaborative,uses,framework

diverse,environments,toolkit

3d,displays,navigation

history,mining,patterns

analytics,anomalies,detect

querying,series,temporal

state,displayed,explored



**CENDARI**  
COLLABORATIVE EUROPEAN DIGITAL  
ARCHIVE INFRASTRUCTURE

[Home](#) [Browse](#) [About](#) [Issue Report](#) [Survey](#)

[anthi](#)

---

**Resources** << >>

**My Projects:**

- Green Cadres
- WW1
  - Notes (1)
    - Green Cadres Notes
  - Documents (144)
  - Entities (7)
    - Event (1)
    - Organization (0)
    - Person (3)
    - Publication (0)
    - Artifact (0)
    - Place (5)
    - Tag (3)

New Save Import Help

Note 5: Green Cadres Notes

Entities (12) Status (Open) Assigned Users

Green Cadres Notes

Note Description [ Read Only ] --- click here for Edit mode

In 1918, as privations and social unrest began to undermine the Austro-Hungarian war effort on the home front, a specific kind of revolt gripped the countryside in a number of regions of the empire. The so-called **Green Cadres** or **Green Brigades** were groups of armed deserters, supplemented by the local poor peasantry, who hid themselves in forested areas, staging raids on livestock and crops, attacking the local gendarmerie and military, and (in some instances) articulating social revolutionary programs. Reports on these irregular armed bands abounded in the final year of the year in many regions of both **Austria and Hungary** but they were concentrated in **Croatia-Slavonia** (current Croatia and **Serbia**) and southern **Moravia** (current Czech republic). The **Green Cadres** represented a specifically rural form of unrest—largely unhitched from **nationalist** and party political agendas—reflecting the widespread sense of apocalyptic collapse among the rural population of Austria-Hungary.

The historical research on the Green Cadres is scant and preponderantly concentrated on the region of **Croatia-Slavonia**, where the Cadres were most numerous and their actions most ambitious. Communist-era **Yugoslav** scholarship treated the Green Cadres as proto-Bolsheviks, overemphasizing the prevalence of **Leninist** ideas among them. Indeed, research has revealed that soldiers returning from Russian imprisonment in 1918 played leading roles in mass desertions, mutinies, and the propagation of social-revolutionist ideas. But scholars have not identified the specific mechanisms by which former POWs became Green Cadres or how the Russian experience was reinterpreted in rural Austro-Hungarian contexts. More importantly, a comparative study of the cadres in various regions is missing because of the challenges of finding, organizing, and interpreting sources that are now fragmented in various national archival research 'siloes'.

This project seeks to open up comparative vistas on the problem of the Green Cadres. Among the possible questions it seeks to answer are: 1. How did the far-flung groups identified as Green Cadres compare to each other in terms of actions and aims; 2. Why did the Cadres appear in the places that they did?; 3. What were the social, political, and cultural factors that facilitated the formation or concentration of Cadres in specific locales? 4. What kind of **deserters** made up the bulk of the Cadres—deserters from the front, replacement regiments, or allotted leave after returning from **Russian internment**?; 5. What played a bigger role in the formation of Green Cadres: social revolutionary influences from Russian imprisonment or disillusionment with the war effort?

**Visualizations** >>

Most Common Person **FRAPET, Guillaume**



Most Common Place **Nantes** 128 docs



Most Recent **Date: 1711/1/29** 1711-1-29

Oldest **Date: 1669/6/5** 1669-6-5



Most Common Place **Nantes** 128 docs



# DOCUMENT SIMILARITY & CLUSTERING

## COMPUTE SIMILARITY BETWEEN DOCUMENTS BASED ON THE WORDS THEY SHARE

- TF-IDF (TERM FREQUENCY-INVERSE DOCUMENT FREQUENCY) IS COMMON

## TOPIC MODELING APPROACHES

- ASSUME DOCUMENTS ARE A MIXTURE OF TOPICS
  - TOPICS ARE (ROUGHLY) A SET OF CO-OCCURRING TERMS
  - LATENT SEMANTIC ANALYSIS (LSA): REDUCE TERM MATRIX
- 
- MANY, MANY APPROACHES EXIST

# Stanford Ph.D. Dissertation Browser

Examine topic distance between Stanford departments.  
Explore dissertations by departments and topics.

Topic Models by Daniel Ramage  
Visualization by Jason Chuang  
(Stanford Mimir Project)

Click on a Dept Circle to begin »

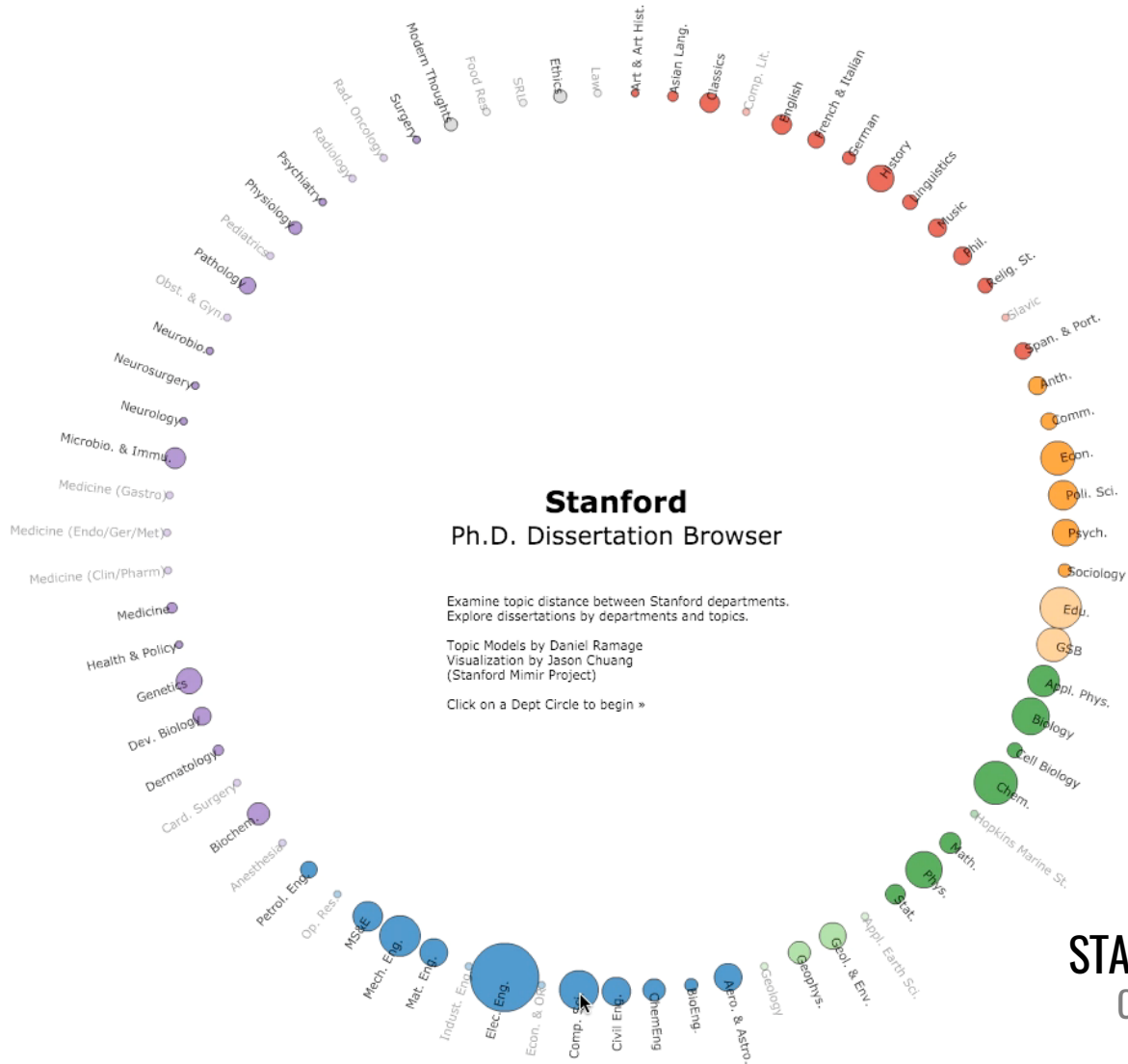

# STANFORD DISSERTATION BROWSER

CHUANG, RAMAGE, MANNING & HEER 2012

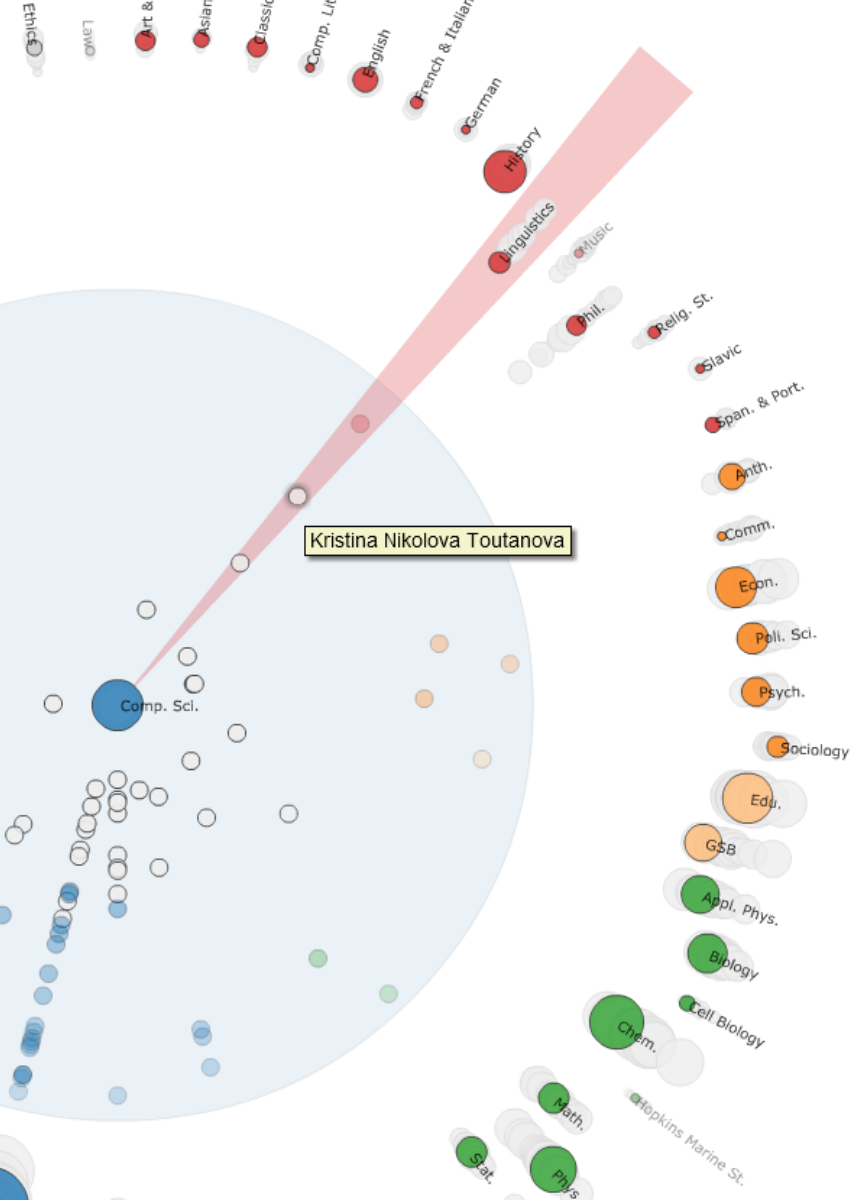

## Effective statistical models for syntactic and semantic disambiguation

Student: Kristina Nikolova Toutanova

Advisor: Christopher D. Manning

Computer Science (2005)

Keywords: Syntactic, Semantic, Tree kernels, Parsing

Abstract:

This thesis focuses on building effective statistical models for disambiguation of sophisticated syntactic and semantic natural language (NL) structures. We advance the state of the art in several domains by (i) choosing representations that encode domain knowledge more effectively and (ii) developing machine learning algorithms that deal with the specific properties of NL disambiguation tasks--sparsity of training data and large, structured spaces of hidden labels. For the task of syntactic disambiguation, we propose a novel representation of parse trees that connects the words of the sentence with the hidden syntactic structure in a direct way. Experimental evaluation on parse selection for a Head Driven Phrase Structure Grammar shows the new representation achieves superior performance compared to previous models. For the task of disambiguating the semantic role structure of verbs, we build a more accurate model, which captures the knowledge that the semantic frame of a verb is a joint structure with strong dependencies between arguments. We achieve this using a Conditional Random Field without Markov independence assumptions on the sequence of semantic role labels. To address the sparsity problem in machine learning for NL, we develop a method for incorporating many additional sources of information, using Markov chains in the space of words. The Markov chain framework makes it possible to combine multiple knowledge sources, to learn how much to trust each of them, and to chain inferences together. It achieves large gains in the task of disambiguating prepositional phrase attachments.

# WARNING

OFTEN, TEXT VISUALIZATIONS DO NOT REPRESENT TEXT DIRECTLY, BUT THEY REPRESENT A MODEL  
WORD COUNTS, WORD SEQUENCES, CLUSTERS, ETC.

**ASK:**

CAN YOU INTERPRET THE VISUALIZATION?

DOES THE MODEL ACCURATELY REPRESENT THE ORIGINAL TEXT?

# LESSONS FOR TEXT VISUALIZATION

**SHOW SOURCE TEXT (OR PROVIDE ACCESS TO IT)**

WHERE POSSIBLE, USE VISUALIZATION AS INDEX INTO DOCUMENTS

**GROUP DOCUMENTS IN MEANINGFUL WAYS**

WILL VIEWERS UNDERSTAND THE CLUSTERS?

**WHERE POSSIBLE USE TEXT TO REPRESENT TEXT**



# HUNDREDS OF TOOLS & TECHNIQUES FOR TEXT AT <http://textvis.lnu.se/>

The screenshot shows a web browser window with the URL [textvis.lnu.se](http://textvis.lnu.se/). The page title is "Text Visualization Browser" and the subtitle is "A Visual Survey of Text Visualization Techniques". It is provided by the ISOVIS group. The interface includes a search bar, a time filter set to 2016, and a grid of 48 different text visualization techniques. A tooltip points to one of the techniques, labeled "Visual Plagiarism Analysis Tool (2015)".

**Text Visualization Browser**  
A Visual Survey of Text Visualization Techniques  
Provided by ISOVIS group

Techniques displayed: **272**

Search:

Time filter: 1976 2016

Analytic Tasks

- Sum
- Alert
- Heart
- Like
- Bell
- Share
- Text
- Refresh
- Edit

Visual Plagiarism Analysis Tool (2015)

Display a menu

[HTTPS://YOUTU.BE/H0EX1IU57IW?T=420](https://youtu.be/H0EX1IU57IW?T=420)

Getting to know David McCandless

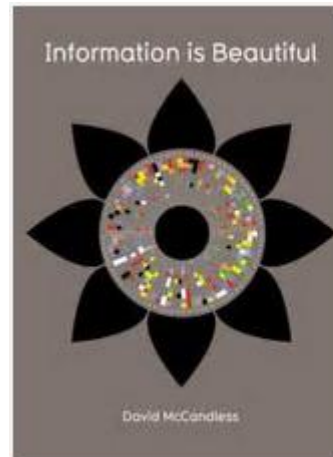

[HTTP://WWW.WEFEELFINE.ORG/](http://www.wefeelfine.org/)

**QUESTIONS?**

# ACKNOWLEDGEMENTS

Slides in were inspired, adapted, taken from slides by

- Christopher Collins (University of Ontario Institute of Technology)
- Wesley Willett (University of Calgary)